







-  **Haute Intelligibilité**
-  **Indice de protection IP 55**
-  **Polyvalent et discret**
-  **Installation simple et rapide**

Le **RB-5019** est un diffuseur sonore de type projecteur de son de 6W, doté d'un haut - parleur bi-cône.

Son système de fixation facilite son orientation et garantit une installation simple et rapide : fixé au mur ou au plafond.

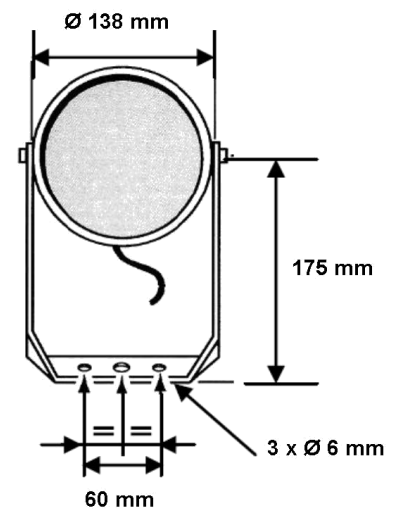

Son corps en ABS convient parfaitement à des environnements sévères et assure une installation durable et résistante. Il peut donc être installé dans tous types d'environnements.



Caractéristiques

Haut-parleur		Bi-cône
Puissances	6W nominale	6 - 3 - 1,5W
Bande Passante		180Hz - 19kHz
SPL	92,5dBA/1W/1m	100dBA/6W/1m
Directivité -6dB		110°
Dimensions		138 x 200 mm
Couleur	Blanc	RAL 9016
Matière		ABS
Poids		1,5Kg

Applications

- Ambiance humide 
- Musique..... 
- Parole..... 

-  **Campings**
-  **Circulations**
-  **Locaux techniques**
-  **Parkings**
-  **Quais de gare**
-  **Voies urbaines**