





-  **Milieux bruyants**
-  **Indice de protection IP 66**
-  **Portée du champ direct 130m**

Le **RP-642** est un diffuseur sonore de type chambre à compression. Son haut-rendement garantit une restitution parfaite de la parole et assure une excellente répartition sonore. Fabriqué en ABS, il résiste aux intempéries et aux chocs.

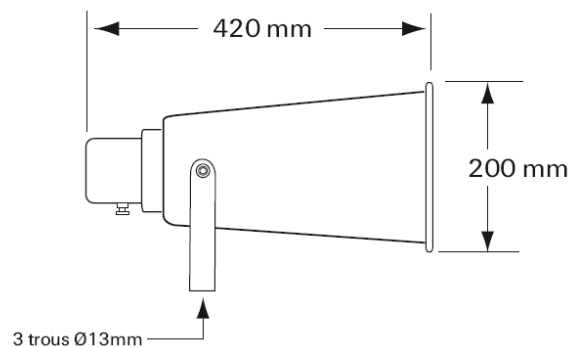

Il peut donc être utilisé dans tous types de lieux extérieurs. Son système de fixation facilite son orientation et garantit une installation simple et rapide.







Caractéristiques

| | | |
|-------------------------|--------------|------------------------|
| Puissances | 40W nominale | 40 - 30 - 20 - 10 - 5W |
| Bande Passante | | 300Hz - 7kHz |
| SPL | 111dBA/1W/1m | 123dBA/40W/1m |
| Directivité -6dB | | 40° x 60° |
| Dimensions | | 400 x 200 x 420mm |
| Couleur | Gris clair | RAL 7035 |
| Matière | | ABS |
| Poids | | 3,9Kg |

Applications

- Extérieur** 
- Parole**..... 

-  **Halls d'exposition**
-  **Piscines**
-  **Rues**
-  **Stades / Terrains de sport**
-  **Usines**