







-  **Très discret**
-  **Compact**
-  **Polyvalent**
-  **Installation simple et rapide**

Le **RB-301** est un diffuseur sonore en ABS doté d'un haut-parleur de type halogène.

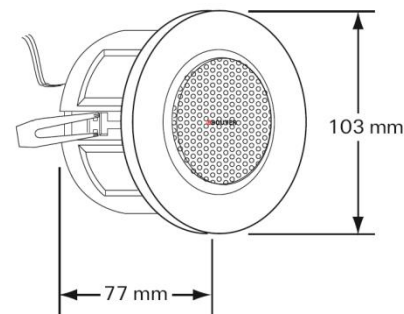

Sa taille et son poids font de ce HP l'un des plus discrets du marché. Son dispositif de montage s'adapte à tous types de faux-plafond, ce qui garantit un montage aisé et sûr et permet une maintenance rapide et facile. Sa membrane tropicalisée assure une installation durable et résistante à l'humidité.



Caractéristiques

Haut-parleur		Type halogène
Puissances	6W nominale	6 - 3 - 1,5W
Bande Passante		90 - 20 000Hz
SPL	83dBA/1W/1m	92dBA/6W/1m
Directivité -6dB		160°
Dimensions	Perçage Ø 95mm	Ø 103 x 77mm
Couleur	Blanc	RAL 9010
Matière	Grille métal	ABS
Poids		0,4Kg

Applications

- Ambiance humide** 
- Musique**..... 
- Parole**..... 

-  **Boutiques**
-  **Bureaux**
-  **Couloirs**
-  **Halls / Accueil**
-  **Sanitaires**
-  **Vestiaires**